

RoHS

SPECIFICATION:

- Rated Current: 1.0A
 - Rated Voltage: 200V
 - Insulation Resistance: 500MΩ Min
 - Withstand Voltage: 500VAC (1Min)
 - Contact resistance: 20mΩ (Max)
 - Working temperature: -25°C to +85°C
- Material:
- Housing: PBT (UL94V-0) Beige
 - Fitting nail: Phosphor Bronze
 - Plating: Tin Plating

Ordering Information

FPC 125 48 A0 - xxP V Z S 2 168

Pitch 125=1.25mm Height H=4.8mm Model No. of Pins See Table Type DIP WV Foot Position Z=Positive F=Reverse Coating G=Gold S=Tin Package 1=Tape&Reel 2=Tube 3=Tray

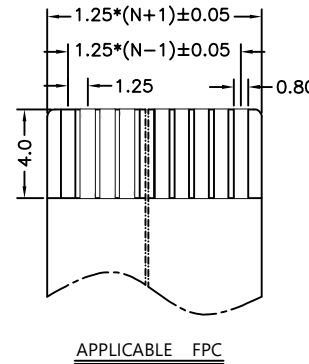
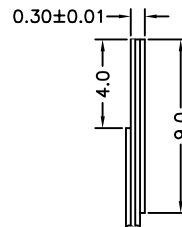
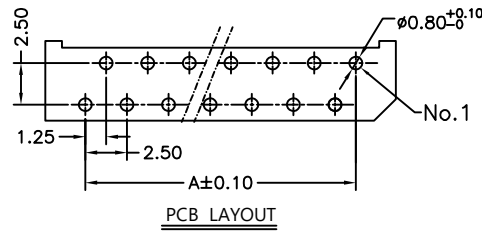
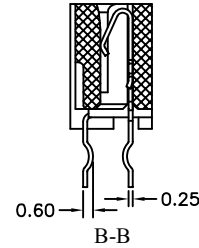
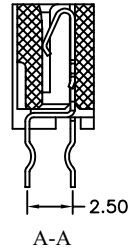
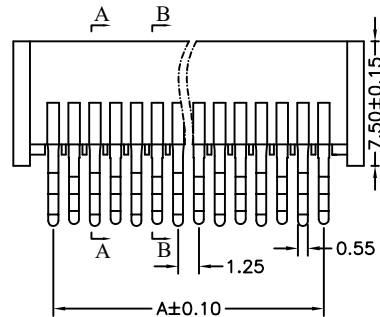
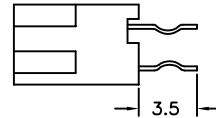
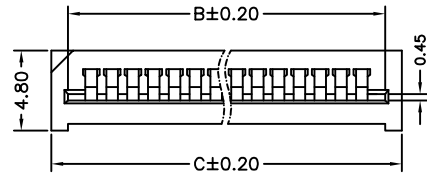

PIN	Dim A	Dim B	Dim C	PIN	Dim A	Dim B	Dim B
4	3.75	6.25	8.55	23	27.50	30.00	32.30
5	5.00	7.50	9.80	24	28.75	31.25	33.55
6	6.25	8.75	11.05	25	30.00	32.50	34.80
7	7.50	10.00	12.30	26	31.25	33.75	36.05
8	8.75	11.25	13.55	27	32.50	35.00	37.30
9	10.00	12.50	14.80	28	33.75	36.25	38.55
10	11.25	13.75	16.05	29	35.00	37.50	39.80
11	12.50	15.00	17.30	30	36.25	38.75	41.05
12	13.75	16.25	18.55	31	37.50	40.00	42.30
13	15.00	17.50	19.80	32	38.75	41.25	43.55
14	16.25	18.75	21.05	33	40.00	42.50	44.80
15	17.50	20.00	22.30	34	41.25	43.75	46.05
16	18.75	21.25	23.55	35	42.50	45.00	47.30
17	20.00	22.50	24.80	36	43.75	46.25	48.55
18	21.25	23.75	26.05	37	45.00	47.50	49.80
19	22.50	25.00	27.30	38	46.25	48.75	51.05
20	23.75	26.25	28.55	39	47.50	50.00	52.30
21	25.00	27.50	29.80	40	48.75	51.25	53.55
22	26.25	28.75	31.05				

SCONDAR ELECTRONIC, LTD
ENGINEER XJ2411

OPERATION	DRAW	YAO	2021.07.06	SCALE	-
X.X ±0.35	DESIGN	Xiong	2021.07.08	UNIT	mm
X.XX ±0.25	CHECK	Lisa	2021.07.11	SIZE	A4
X.XXX ±0.15	APPROVE			SHEET	1/1
Angle ± 3'				PROJ.	⊕
DIM TOL				TITLE:	



SCONDAR ELECTRONIC LIMITED

REV	DATE	MODIFICATION DESCRIPTION	CHANGE	APPROVE
A0	2021.03.08	NEW		

PART NO. FPC12548A0-xxPVZS2168

TITLE: FPC 1.25mm H=4.8 "A" Model NO LID WV PBT VO Beige xxP Contact Tin Plating Tube Package