

SPECIFICATIONS

Voltage rating: 150V AC,DC
 Current rating: 1A, AC, DC
 Withstanding Voltage:1000V AC/minute
 Insulation resistance:1000MΩ min
 Temperature range:-25℃ - +85
 Contact resistance:40mΩ max

Part No:300BTB
 Material:LCP, UL94V-0
 Cotact:Phosphor bronze, Tin plated
 Q' TY:1,000PCS/Reel

Ordering Information

300BTB-MWR-02 S F 1 BE 182

F=Female
 M=Male

Plating
 S= Tin Plated

Material
 F=LCP

Package
 1=Tape&Reel

Color
 BE=Beige

PCB LAYOUT

SCONDAR ELECTRONIC LIMITED
 ENGINEER LIU APPROVED

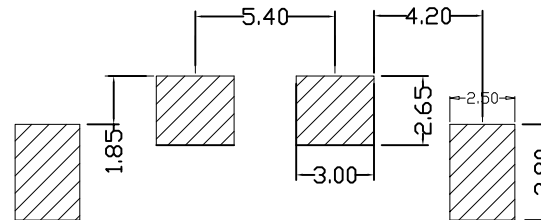
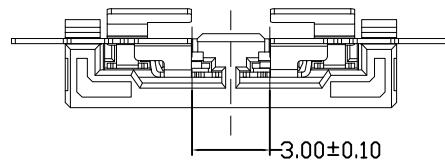
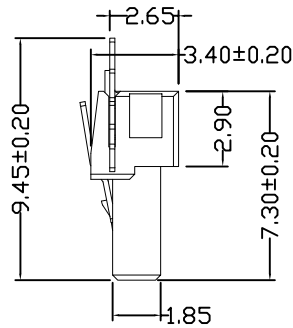
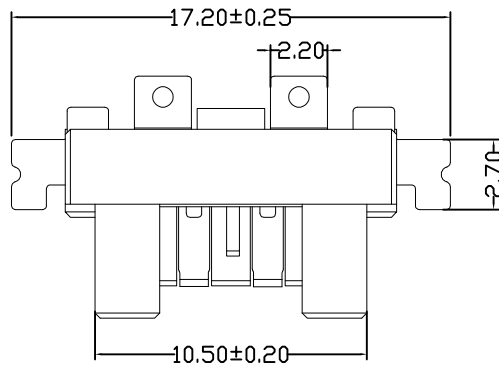
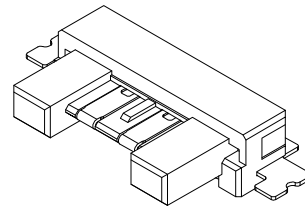
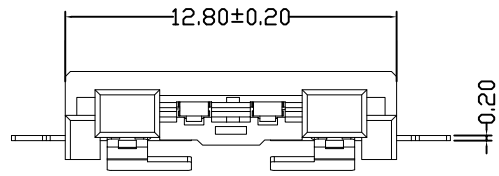

						OPERATION	DRAW	Zhong	2020.11.05	SCALE		 森康达电子有限公司 SCONDAR ELECTRONIC LIMITED	
						~ 10 ±0.15	DESIGN			UNIT	mm		
						20 ~ 30 ±0.30	CHECK	Micky	2020.11.05	SIZE	A4	PART NO.	300BTB-MWR-02SF1BE182
0	05/12/27		NEW			30 ~ ±0.50	APPROVE			SHEET	1/1	TITLE:	BTB3.0mm 02Pin male SMT Right angle Header LCP V0 Beige Tin(Sn) Plating Tape and Reel MPQ=1KPCS
REV	DATE		MODIFICATION DESCRIPTION	CHANGE	APPROVE	Angle ± 2'				PROJ.			
						DIM TOL							