

RoHS

Recommended P.C.B Layout
General Tolerance±0.05

- Specification:
- Current Rating: 1A AC/DC
 - Voltage Rating: 150V AC/DC
 - Insulation Resistance: 500MΩ Min
 - Withstanding Voltage: 500VAC(1Min)
 - Contact resistance: 20mΩ(Max).
 - Operation Temperature: -40°C to +85°C

- Material:
- Insulator (Housing): Nylon 9T (UL94V-0)
 - Contacts: Brass, Tin Plated
 - Color: White

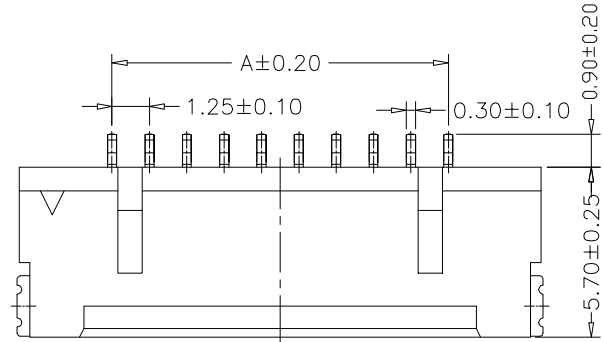

04P~30P

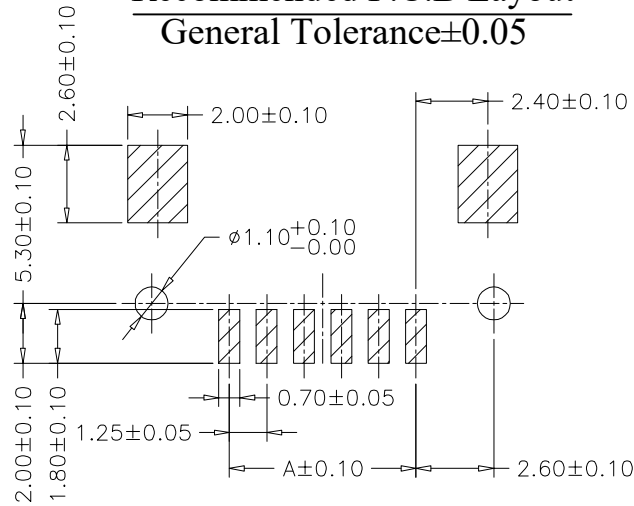

Ordering Information

SCT1253WRSF - ** E * WT 101

No. of Pins See Table
Insulation E=PA9T
Package 1=Tape&Reel 2=Tube
Color WT=White

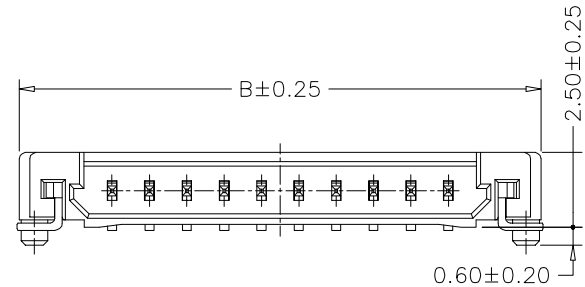

0.60±0.20

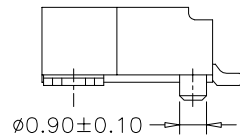

东莞市晟凯达电子科技有限公司
工程专用章

受控

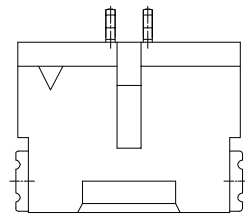
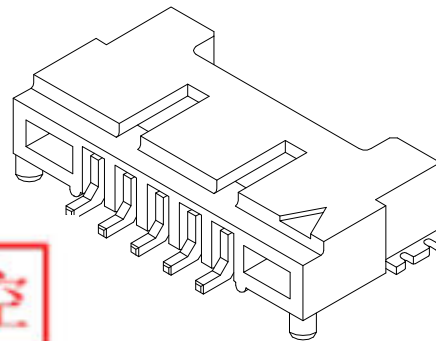

02P

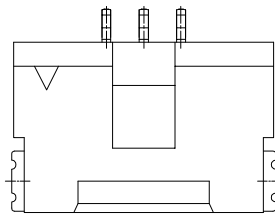

03P

11	12.50	18.70			
10	11.25	17.45			
9	10.00	16.20	30	36.25	42.45
8	8.75	14.95	25	30.00	36.20
7	7.50	13.70	20	23.75	29.95
6	6.25	12.45	15	17.50	23.70
5	5.00	11.20	14	16.25	22.45
4	3.75	9.95	13	15.00	21.20
3	2.50	8.95	12	13.75	19.95
Poles	A	B	Poles	A	B
	Dimensions			Dimensions	

REV	DATE	MODIFICATION DESCRIPTION	CHANGE	APPROVE	OPERATION	DRAW	SCALE	UNIT	SIZE	SHEET	PROJ.	PART NO.	TITLE:
A0	2006.05.02	NEW			X.X	±0.35		mm	A4	1/1		SCT1253WRSF-xxExWT101	DF14 1.25mm 90° SMT Wafer
					X.XX	±0.25							
					X.XXX	±0.15							
					Angle	± 3'							
					DIM	TOL							



SCONDAR ELECTRONIC LIMITED