

RoHS

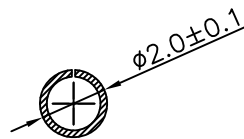
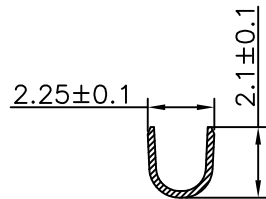
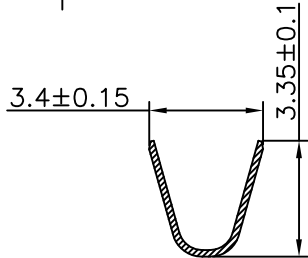
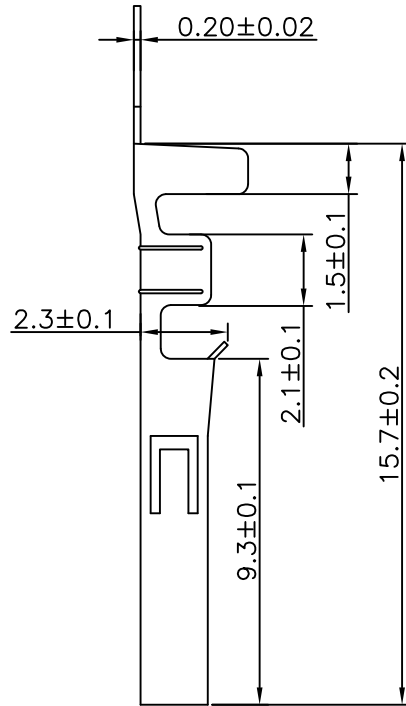
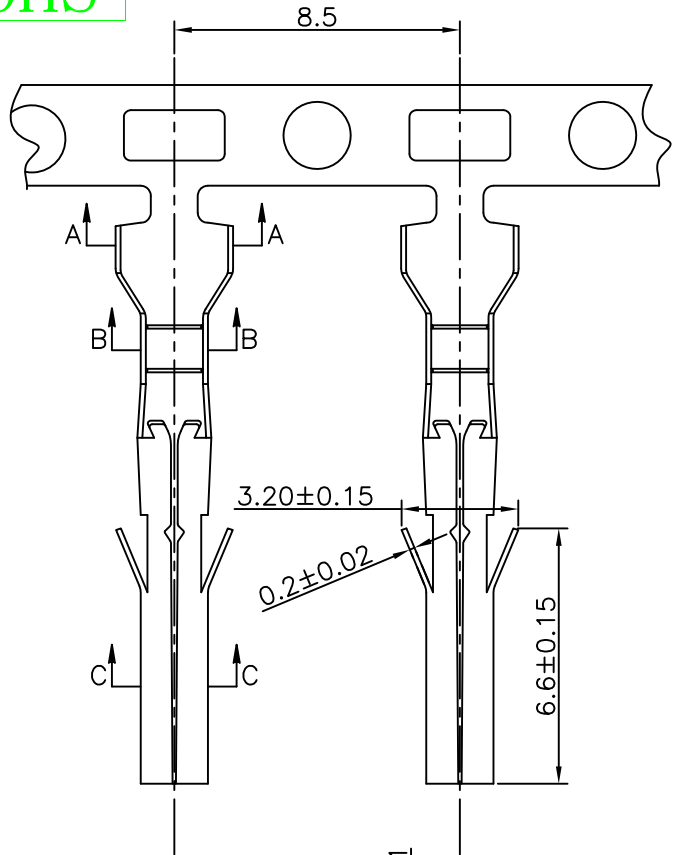

SECTION:A-A

SECTION:B-B

C向

Specification:

- Current Rating: 5A AC/DC
- Voltage Rating: 250V AC/DC
- Insulation Resistance: 1000MΩ Min
- Withstanding Voltage: 1500VAC(1Min)
- Contact resistance: 20mΩ(Max).
- Operation Temperature: -25°C to +85°C

Material:



- Wire Range: 18-26AWG(OD:2.5mm)
- Material: Phosphor Bronze
- Finish: Tin Plated

Ordering Information

SCT3700FT P S 102

Material:
P=Phosphor Bronze

Contact Plated
S=Tin Flash

					OPERATION	DRAW	Peng	2021.07.09	SCALE	-	 SCONDAR ELECTRONIC LIMITED		
					X.X ±0.35	DESIGN			UNIT	mm			
					X.XX ±0.25		CHECK	Lisa	2021.07.09	SIZE		A4	
A1	2021.07.09	Changed from SCT3700-FTP to SCT3700FTPS102			X.XXX ±0.15	APPROVE	Allen	2021.07.09	SHEET	1/1	PART NO.	SCT3700FTPS102	
AO	2018.03.03	NEW			Angle ± 3'				PROJ.		TITLE:	1.58 Female Terminal	
REV	DATE	MODIFICATION DESCRIPTION	CHANGE	APPROVE	DIM	TOL							