

RoHS

Specification:

- Current Rating: 7A AC/DC
- Voltage Rating: 250V AC/DC
- Insulation Resistance: 1000MΩ(Min)
- Contact resistance: 20mΩ(Max).
- Withstanding Voltage: 1500VAC(Min)
- Operation Temperature: -25°C to +85°C

Material:

- Wire Range:18-22AWG
- Material: Phosphor Bronze, T=0.25mm
- Finish: Tin Plated
- Q'TY: 3,000Pcs/Reel

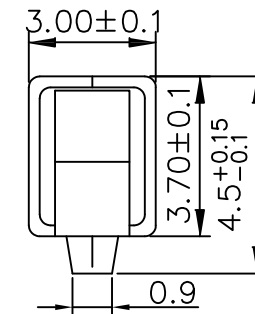
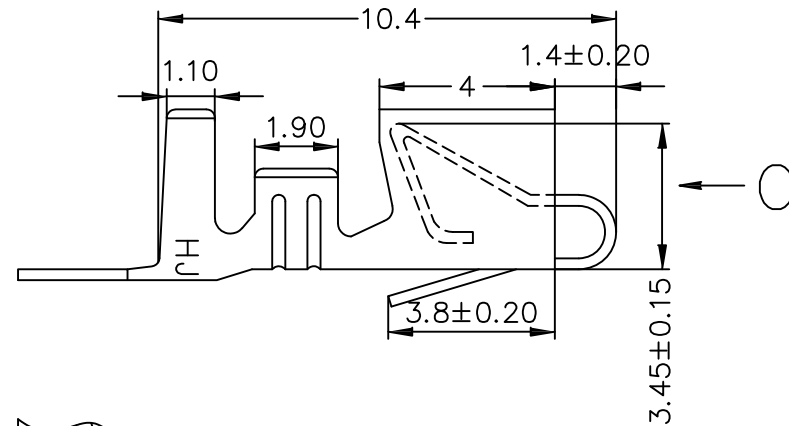

SECTION: C-C

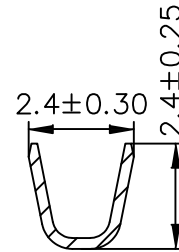

SECTION: B-B

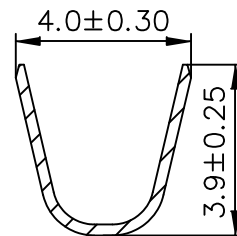

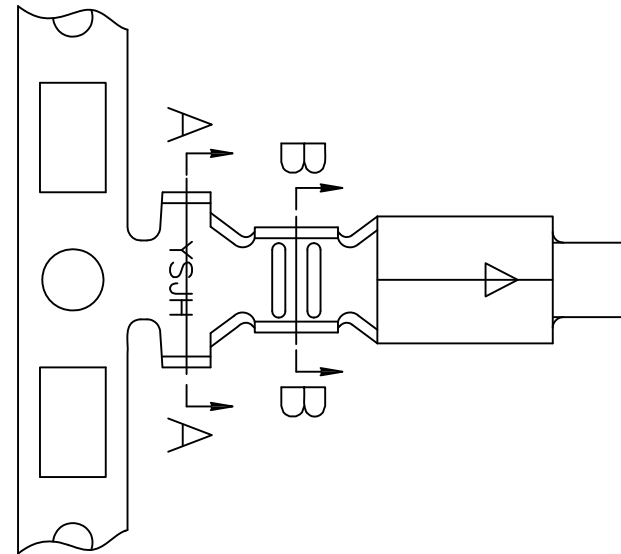

SECTION: A-A



Ordering Information

SCT3961T P S 109

Material: P=Phosphor Bronze S=Tin Plated

					OPERATION	DRAW	Peng	2021.07.10	SCALE	-	 SCONDAR ELECTRONIC LIMITED		
					X.X ±0.35	DESIGN			UNIT	mm			
					X.XX ±0.25		CHECK	Lisa	2021.07.10	SIZE		A4	
A1	2021.07.10	Changed from SCT3961-TP to SCT3961TPS109			X.XXX ±0.15	APPROVE	Allen	2021.07.10	SHEET	1/1	PART NO.	SCT3961TPS109	
AO	2018.03.03	NEW			Angle ± 3'				PROJ.		TITLE:	VH3.96 Terminal	
REV	DATE	MODIFICATION DESCRIPTION	CHANGE	APPROVE	DIM	TOL							