

RoHS

受控

Specification:

- Current Rating: 8A AC/DC
- Voltage Rating: 300V AC/DC
- Insulation Resistance: 1000MΩ Min
- Withstanding Voltage: 1000VAC(1Min)
- Operation Temperature: -25°C to +85°C
- Contact resistance: 20mΩ(Max)

Material:

- Insulator (Housing): PA66
- Color: Beige

东莞市晟凯达电子科技有限公司  
工程专用章

Ordering Information

SCT28050MH - \*\* B BE 102



No.of Pins  
See Table

Insulation  
B=PA66

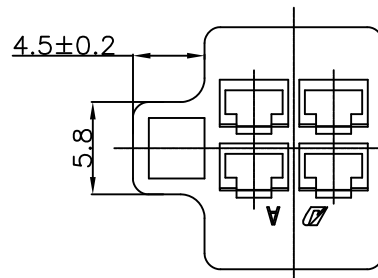
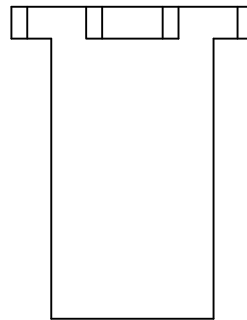
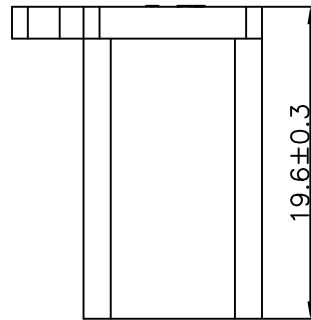
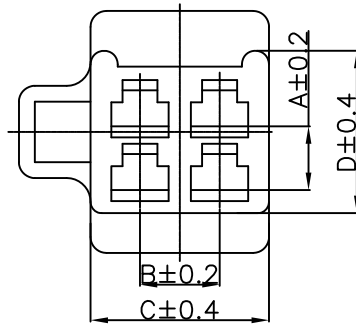
Color  
BE=Beige



9	8.00	10.0	16.2	14.2
6	8.00	5.00	11.2	14.2
4	4.00	5.00	11.2	10.2
3	8.00	/	6.20	14.2
2	4.00	/	6.20	10.2
Poles	A	B	C	D
	Dimensions			

					OPERATION	DRAW	Peng	2006.05.02	SCALE	-	 SCONDAR ELECTRONIC LIMITED		
					X.X ±0.35	DESIGN			UNIT	mm			
A1	2021.07.12	Changed from SCT28050MH-xxP to SCT28050MH-xxBNA102			X.XX ±0.25		CHECK	Lisa	2006.05.02	SIZE		A4	
AO	2006.05.02	NEW			X.XXX ±0.15	APPROVE	Allen	2006.05.02	SHEET	1/1		PART NO.	SCT28050MH-xxBBE102 
REV	DATE	MODIFICATION DESCRIPTION	CHANGE	APPROVE	Angle DIM	± 3' TOL	APPROVE	Allen	2006.05.02	PROJ.		TITLE:	28050 Male Housing Connector