

RoHS

Specification:

- Current Rating: 3A AC/DC
- Voltage Rating: 250V AC/DC
- Insulation Resistance: 1000MΩ Min
- Withstanding Voltage: 1500VAC(1Min)
- Contact resistance: 20mΩ(Max)
- Operation Temperature: -25°C to +85°C

Material:

- Insulator (Housing): PBT/PA66 (UL94V-0)
- Color: Black

Ordering Information

SCT2549H -2xx D BK 107

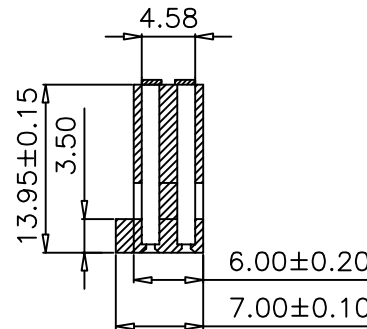
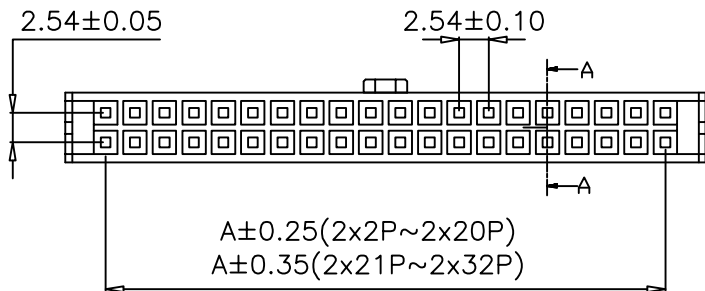
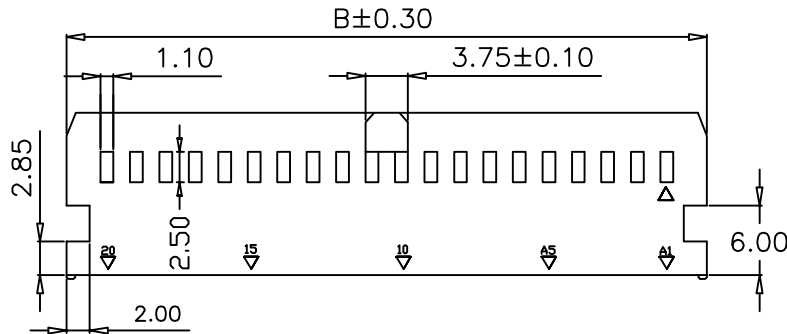
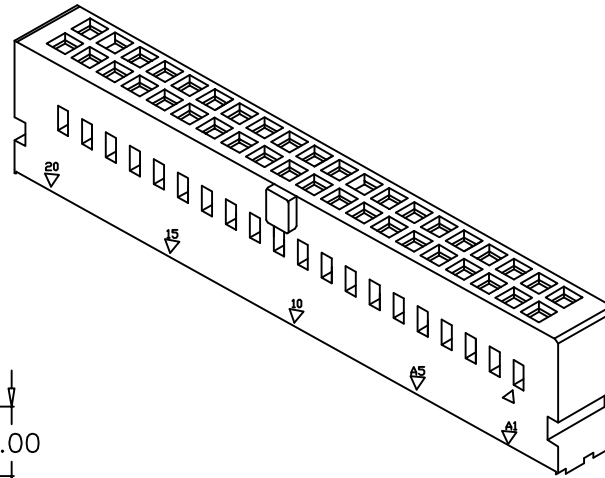

No. of Pins See Table
Insulation D=PBT
Color BK=Black

2x11	25.40	32.34	2x21	50.08	57.74	2x31	76.20	83.14
2x10	22.86	29.80	2x20	48.26	55.20	2x30	73.66	80.60
2x9	20.32	27.26	2x19	45.72	52.66	2x29	71.12	78.06
2x8	17.78	24.72	2x18	43.18	50.12	2x28	68.58	75.52
2x7	15.24	22.18	2x17	40.64	47.58	2x27	66.04	72.98
2x6	12.70	19.64	2x16	38.10	45.04	2x26	63.50	70.44
2x5	10.16	17.10	2x15	33.56	42.50	2x25	60.96	67.90
2x4	7.62	14.56	2x14	33.02	39.96	2x24	58.42	65.36
2x3	5.08	12.02	2x13	30.48	37.42	2x23	55.88	62.82
2x2	2.54	9.48	2x12	27.94	34.88	2x22	53.34	60.28
Poles	A	B	Poles	A	B	Poles	A	B
	Dimensions			Dimensions			Dimensions	



Section: A-A

SCONDAR ELECTRONIC LIMITED
ENGINEER LIU APPROVED

					OPERATION	DRAW	Zhong	2021.07.10	SCALE	-	 SCONDAR ELECTRONIC LIMITED
					X.X	±0.35			UNIT	mm	
					X.XX	±0.25			SIZE	A4	
					X.XXX	±0.15			SHEET	1/1	
AO		NEW			Angle	± 3'			PART NO.	SCT2549H-2xxDBK107	
REV	DATE	MODIFICATION DESCRIPTION	CHANGE	APPROVE	DIM	TOL	APPROVE	Allen	2021.07.10	PROJ.	 TITLE: HRS2.54mm PBT V0 2x09Pin Crimp Housing Dual Row 1nose slot Black Bag