

RoHS

Recommended P.C.B Layout
General Tolerance±0.05

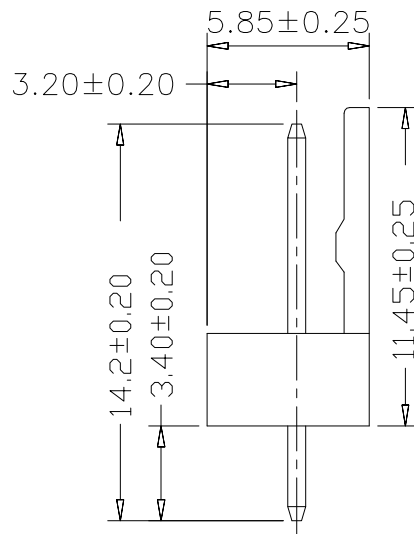
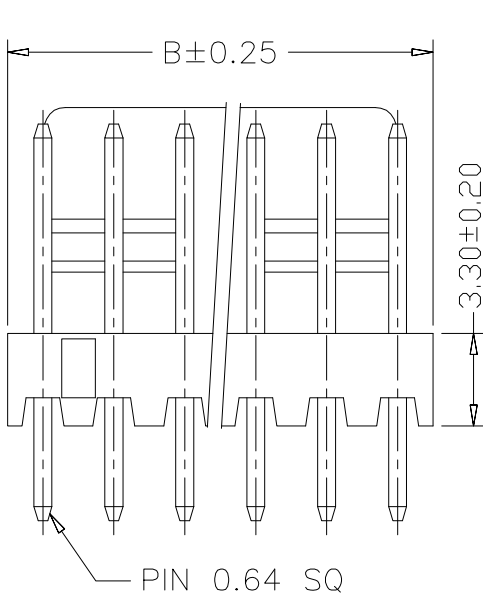
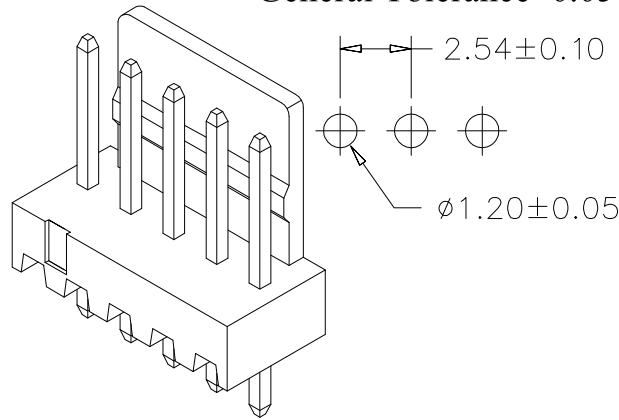
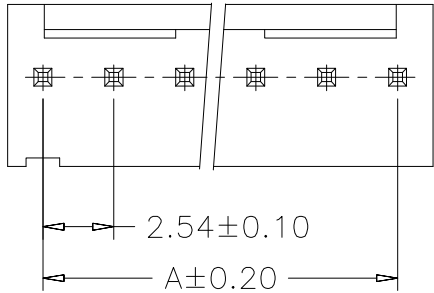

Specification:

- Current Rating: 4A AC/DC
- Voltage Rating: 250V AC/DC
- Insulation Resistance: 1000MΩ Min
- Withstanding Voltage: 1000VAC Min
- Contact resistance: 20mΩ(Max).
- Operation Temperature: -25°C to +85°C

Material:



- Insulator (Housing): PA66 (UL94V-2)
- Contacts: Brass
- Solder: Tin Plated
- Color: Beige

Ordering Information

SCT2541WV - ** C 0 BE 108

No.of Pins See Table
Insulation C=PA66 V2
Package 0=PE Bag
Color BE=Beige

10	22.86	25.40	19	45.72	48.26			
9	20.32	22.86	18	43.18	45.72			
8	17.78	20.32	17	40.64	43.18			
7	15.24	17.78	16	38.10	40.64			
6	12.70	15.24	15	33.56	38.10			
5	10.16	12.70	14	33.02	33.56			
4	7.62	10.16	13	30.48	33.02			
3	5.08	7.62	12	27.94	30.48			
2	2.54	5.08	11	25.40	27.94	20	48.26	50.80
Poles	A	B	Poles	A	B	Poles	A	B
	Dimensions			Dimensions			Dimensions	

REV	DATE	MODIFICATION DESCRIPTION	CHANGE	APPROVE	OPERATION	DRAW	Peng	2021.07.06	SCALE	-	 SCONDAR ELECTRONIC LIMITED	
A1	2021.07.06	Changed from SCT2541WV-xxP to SCT2541WV-xxCOBE108			X.X	±0.35			UNIT	mm		
AO	2019.10.15	NEW			X.XX	±0.25			SIZE	A4		
					X.XXX	±0.15		2021.07.06	SHEET	1/1		
					Angle	± 3'			PART NO.	SCT2541WV-xxCOBE108		
					DIM	TOL	APPROVE	Allen	2021.07.06	PROJ.	 TITLE:	MX2.54mm Pitch 180° Wafer Connector