

RoHS

Specification:

- Current Rating: 3A AC/DC
- Voltage Rating: 250V AC/DC
- Insulation Resistance: 1000MΩ(Min)
- Contact resistance: 20mΩ(Max).
- Withstanding Voltage: 1000VAC(Min)
- Operation Temperature: -25°C to +85°C

Material:

- Wire Range: 22AWG~28AWG(OD:1.9mm)
- Material: Phosphor Bronze, T=0.20mm
- Finish: Tin Plated
- Q'TY: 11,000Pcs/Reel

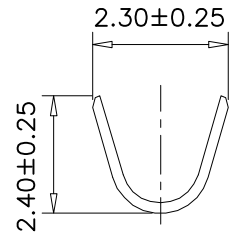
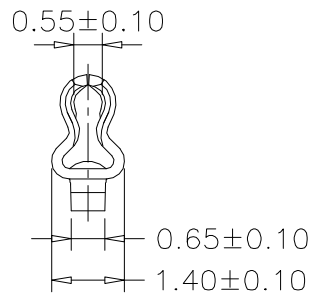
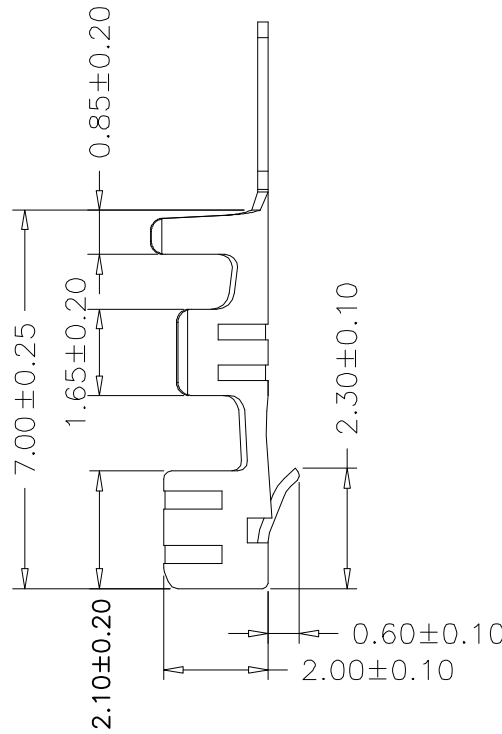
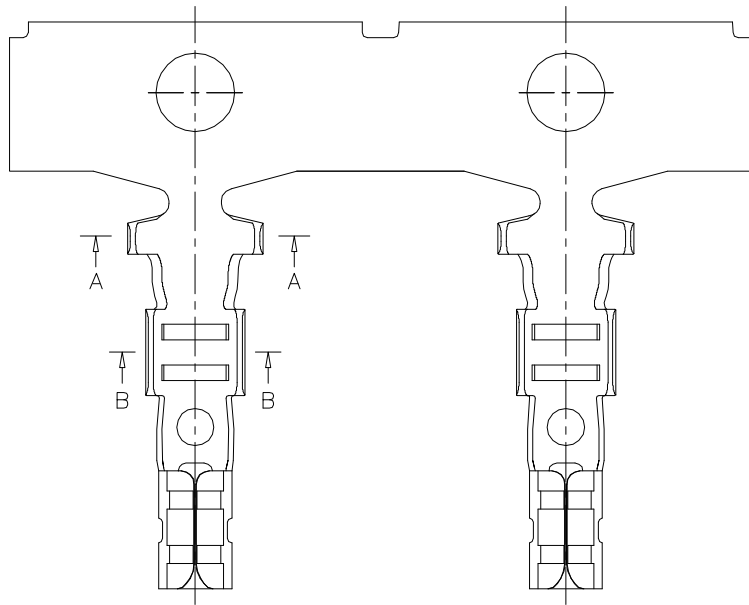

SECTION:A-A

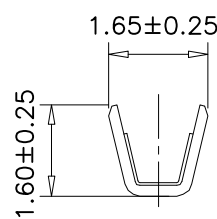



SECTION:B-B

Ordering Information

SCT2513T P S 109

Material:
P=Phosphor Bronze S=Tin Plated

					OPERATION	DRAW	Peng	2021.07.09	SCALE	-	 SCONDAR ELECTRONIC LIMITED		
					X.X ±0.35	DESIGN			UNIT	mm			
					X.XX ±0.25		CHECK	Lisa	2021.07.09	SIZE		A4	
A1	2021.07.09	Changed from SCT2513-TP to SCT2513TPS109			X.XXX ±0.15	APPROVE	Allen	2021.07.09	SHEET	1/1	PART NO.	SCT2513TPS109	
AO	2015.03.03	NEW			Angle ± 3'				PROJ.		TITLE:	MX 2.5mm Terminal	
REV	DATE	MODIFICATION DESCRIPTION		CHANGE	DIM TOL								