

RoHS

**Specification:**

- Current Rating: 3A AC/DC
- Voltage Rating: 250V AC/DC
- Insulation Resistance: 1000MΩ Min
- Withstanding Voltage: 800VAC(1Min)
- Contact resistance: 20mΩ(Max).
- Operation Temperature: -25°C to +85°C

**Material:**

- Material : PA66 ,UL94V-0
- Color: White

**Ordering Information**

SCT2030H F1 - 2 xx B 0 WT 182

F1=TYPE1  
F2=TYPE2  
F3=TYPE3  
No.of Pins  
See Table  
Insulation  
B=PA66 V0  
0=PE Bag  
Color  
WT=White

Poles	Dimensions	
	A	B
2	2.00	6.00
3	4.00	8.00
4	6.00	10.00
5	8.00	12.00
6	10.00	14.00
7	12.00	16.00
8	14.00	18.00
9	16.00	20.00
10	18.00	22.00
11	20.00	24.00
12	22.00	26.00
13	24.00	28.00
14	26.00	30.00
15	28.00	32.00
16	30.00	34.00
17	32.00	36.00
18	34.00	38.00
19	36.00	40.00
20	38.00	42.00

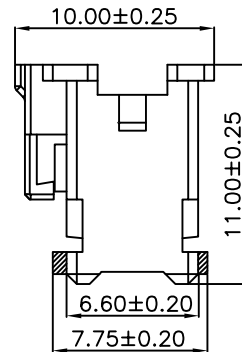
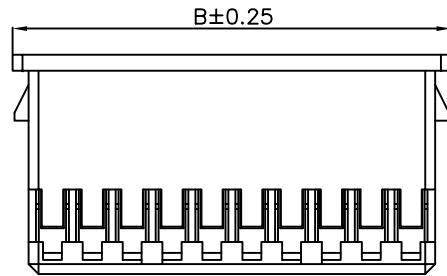

TYPE-3  
7-20P

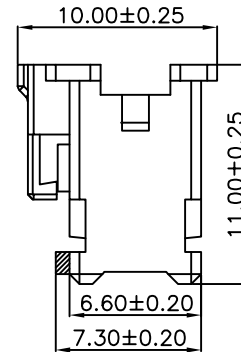

TYPE-2  
5-6P

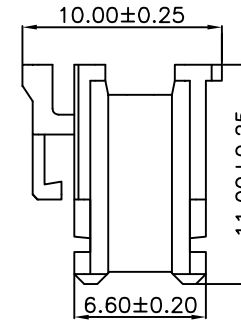

TYPE-1  
2-4P

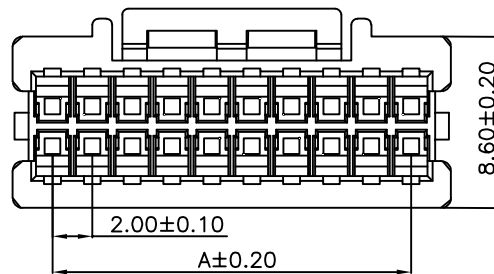

5-20P

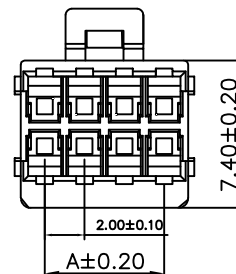

2-4P

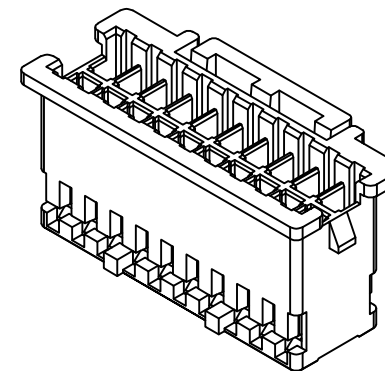

SCONDAR ELECTRONIC, LTD  
ENGINEER APPROVED LIAO

					OPERATION	DRAW	Peng	2021.07.06	SCALE	-	 SCONDAR ELECTRONIC LIMITED	
					X.X	±0.35			UNIT	mm		
					X.XX	±0.25			SIZE	A4		
					X.XXX	±0.15			SHEET	1/1		
AO	2021.07.06	NEW			Angle	± 3'			PART NO.	SCT2030HF1-2xxB0WT182		
REV	DATE	MODIFICATION DESCRIPTION	CHANGE	APPROVE	DIM	TOL	APPROVE	Allen	2021.07.06	PROJ.	TITLE:	SPH 2.00mm PA66 V0 White 2xxP Housing TYPE1