

RoHS

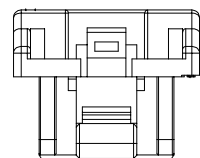

2P-4P

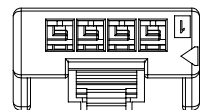
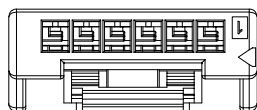

5P-7P

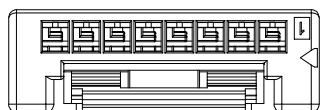

8P-10P

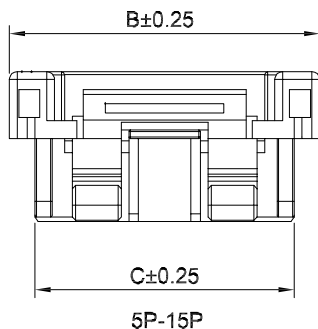
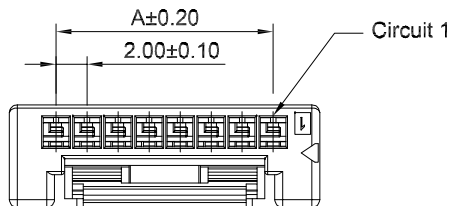

5P-15P

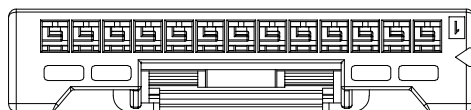
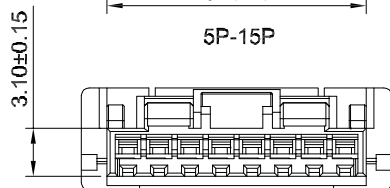

11P-15P

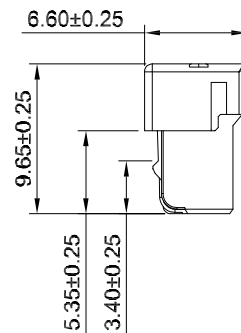
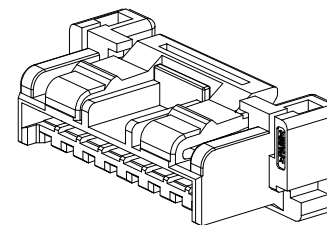

SPECIFICATIONS:
 Current Rating: 3A AC,DC
 Voltage Rating: 250V AC,DC
 Temperature Range: -40°C ~ +105°C
 Contact Resistance: 20mΩ Max.
 Insulation Resistance: 1000MΩ Min.
 Withstanding Voltage: 800V AC/minute
 Material: Nylon 66 UL94V-0(White)

Ordering Information & Dimensions

Part NO.	Dimensions(mm)		
	A	B	C
A2008HE-2P	2.00	8.00	4.70
A2008HE-3P	4.00	10.00	6.70
A2008HE-4P	6.00	12.00	8.70
A2008HE-5P	8.00	14.00	10.70
A2008HE-6P	10.00	16.00	12.70
A2008HE-7P	12.00	18.00	14.70
A2008HE-8P	14.00	20.00	16.70
A2008HE-9P	16.00	22.00	18.70
A2008HE-10P	18.00	24.00	20.70
A2008HE-11P	20.00	26.00	22.70
A2008HE-12P	22.00	28.00	24.70
A2008HE-13P	24.00	30.00	26.70
A2008HE-14P	26.00	32.00	28.70
A2008HE-15P	28.00	34.00	30.70

REV	DATE	MODIFICATION DESCRIPTION	CHANGE	APPROVE	OPERATION	DRAW	YANG	2016.06.06	SCALE	—
A0	2016.06.06	NEW	—	—	X.X ±0.35	DESIGN			UNIT	mm
					X.XX ±0.25	CHECK	Lisa	2016.06.06	SIZE	A4
					X.XXX ±0.15	APPROVE			SHEET	1/1
					Angle ±3°				PROJ.	⌀
					DIM TOL				TITLE:	

SCONDAR
 SCONDAR ELECTRONIC LIMITED

PART NO. SCT2023H-xxBWT136
 TITLE: MAX502439-0600 PA66 VO White xxP with lock Housing