

RoHS

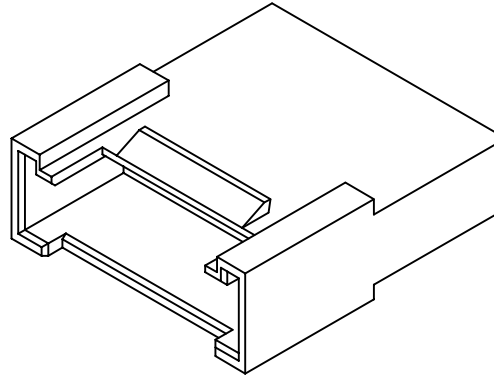
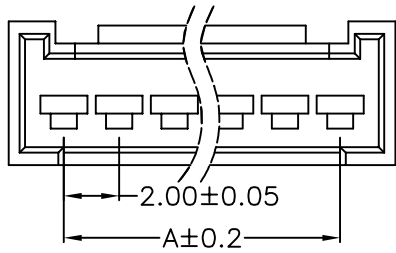

Specification:

- Current Rating: 3A AC/DC
- Voltage Rating: 250V AC/DC
- Insulation Resistance: 1000MΩ (Min)
- Withstanding Voltage: 1000VAC(1Min)
- Contact resistance: 20MΩ MAX.
- Operation Temperature: -25°C to +85°C

Material:

- Insulator (Housing): PA66 (UL 94V-0)
- Color: White

Ordering Information

SCT2006FH- xx B WT 190

No. of Pins See Table      Insulation B=PA66 V0      Color WT=White

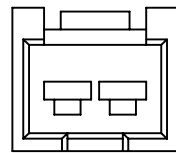
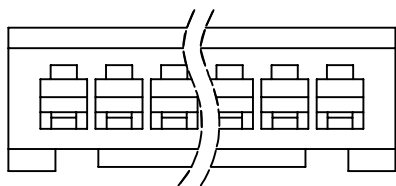
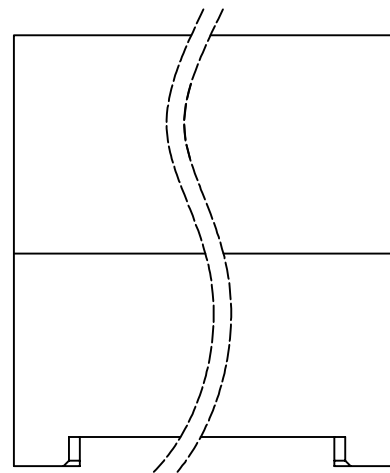
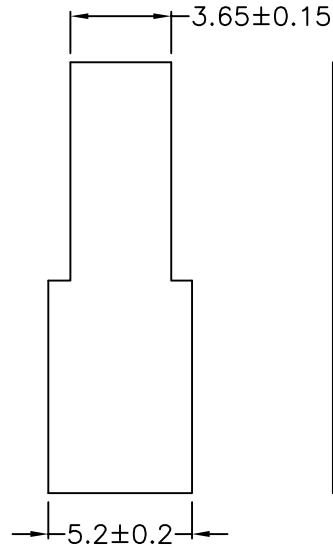
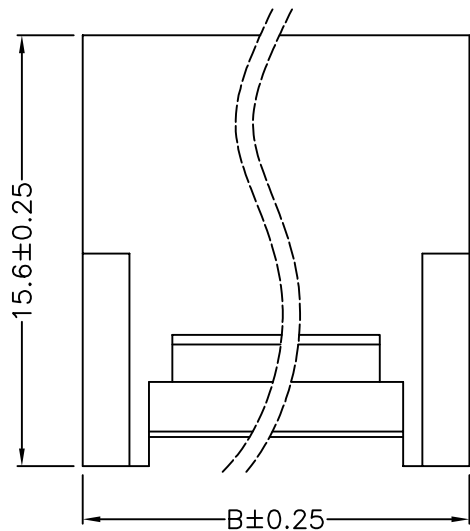

2P

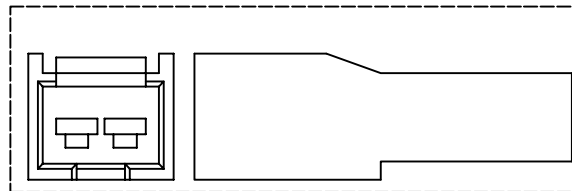

2P Shut Up

PIN	Dimensions		PIN	Dimensions	
	A	B		A	B
2	2.00	6.00	10	18.00	22.00
3	4.00	8.00	11	20.00	24.00
4	6.00	10.00	12	22.00	26.00
5	8.00	12.00	13	24.00	28.00
6	10.00	14.00	14	26.00	30.00
7	12.00	16.00	15	28.00	32.00
8	14.00	18.00	16	30.00	34.00
9	16.00	20.00			

**SCONDAR ELECTRONIC, LTD**  
ENGINEER 20240725

OPERATION		DRAW	YAO	2020.07.13	SCALE	-
X.X	±0.35	DESIGN			UNIT	mm
X.XX	±0.25	CHECK	Lisa	2020.07.16	SIZE	A4
X.XXX	±0.15	APPROVE			SHEET	1/1
Angle	± 3'				PROJ.	⊕
DIM	TOL				TITLE:	



SCONDAR ELECTRONIC LIMITED

REV	DATE	MODIFICATION DESCRIPTION	CHANGE	APPROVE
A0	2020.07.13	NEW		

PART NO.	SCT2006FH-xxBWT190
TITLE:	HY2.00mm PA66 V0 White xxPin Female Housing