

RoHS

Specification:

- Current Rating: 2A AC/DC
- Voltage Rating: 250V AC/DC
- Insulation Resistance: 1000MΩ Min
- Withstanding Voltage: 800VAC(1Min)
- Contact resistance: 20mΩ(Max).
- Operation Temperature: -25°C to +85°C

Material:

- Insulator (Housing): Nylon 66 (UL94V-0)
- Color: Brown

Ordering Information

SCT2005H - xx B BR 131



No.of Pins
See Table

Insulation
B=PA66

Color
BR=Brown

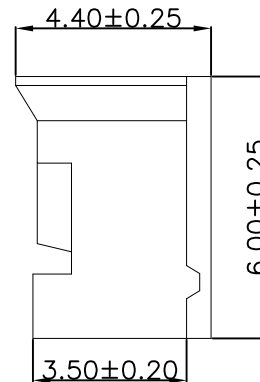
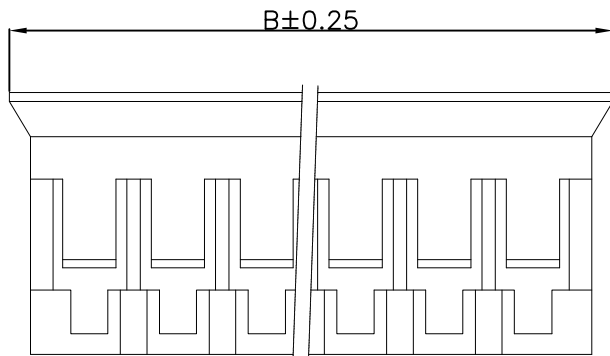
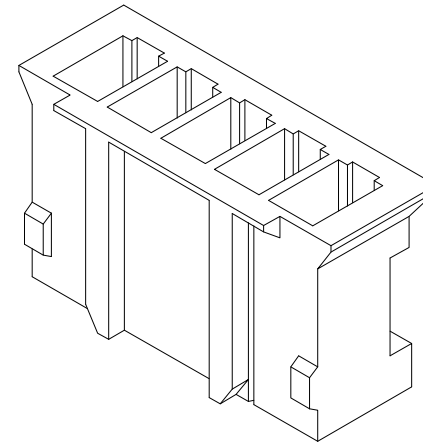
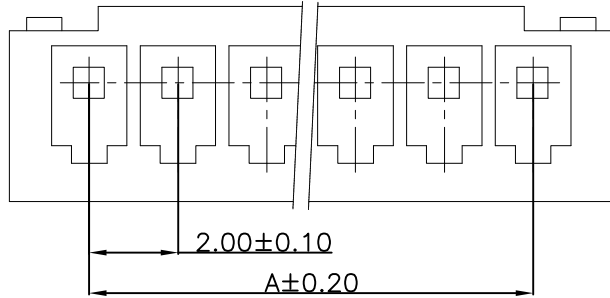
10	18.00	21.60			
9	16.00	19.60			
8	14.00	17.60			
7	12.00	15.60			
6	10.00	13.60	15	28.00	31.60
5	8.00	11.60	14	26.00	29.60
4	6.00	9.60	13	24.00	27.60
3	4.00	7.60	12	22.00	25.60
2	2.00	5.60	11	20.00	23.60
Poles	A	B	Poles	A	B
	Dimensions			Dimensions	



REV	DATE	MODIFICATION DESCRIPTION	CHANGE	APPROVE	OPERATION	DRAW	Peng	2021.07.10	SCALE	-	 SCONDAR ELECTRONIC LIMITED	
A1	2021.07.10	Changed from SCT2005H-xxP to SCT2005H-xxBBR131			X.X	±0.35			UNIT	mm		
AO	2010.04.02	NEW			X.XX	±0.25			SIZE	A4		
					X.XXX	±0.15			SHEET	1/1		
					Angle	± 3'			PART NO.	SCT2005H-xxBBR131		
					DIM	TOL	APPROVE	Allen	2021.07.10	PROJ.	 TITLE:	JAE 2.00mm Pitch Housing Connector